



# Antonius Stradiuarius

*by Jost Thöne Verlag*

*—pdf Sample—*

Jost Thöne Verlag  
Titiseestraße 19, 79853 Lenzkirch—Saig, Germany,  
Phone: +49 (0)171 64 63 597  
E-Mail: [jost.thoene@jost-thoene-verlag.de](mailto:jost.thoene@jost-thoene-verlag.de)  
Internet: [www.jost-thoene-verlag.de](http://www.jost-thoene-verlag.de)



# Antonius Stradiuarius

*Book Samples*

*DVD Samples*

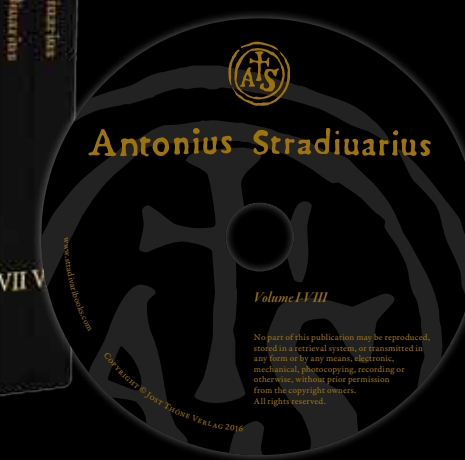
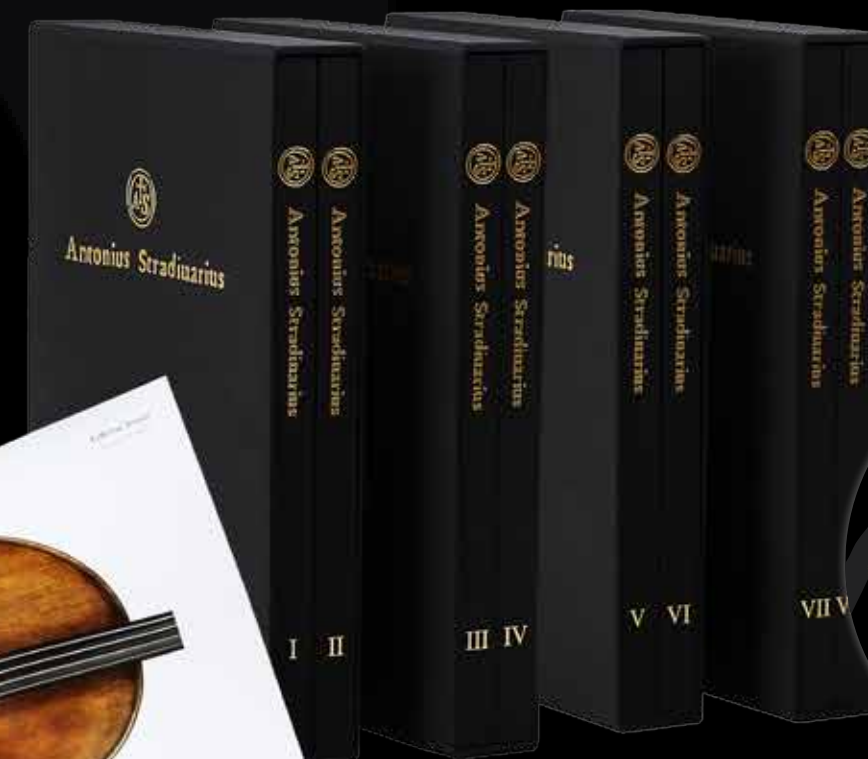



# Antonius Stradiuarius

*Volume I-VIII*

## Credits

### PUBLISHED BY

Jost Thöne  
Jost Thöne Verlag  
[www.jost-thoene-verlag.de](http://www.jost-thoene-verlag.de)  
[www.stradivaribooks.com](http://www.stradivaribooks.com)

### EDITOR

Jost Thöne

### ALL PHOTOS

Jan Röhrmann  
Bronze by Marijke de Vré-Verlaan  
1715 'Lipinski'—by Michael Darnton  
1698 'Zuber'—by Nathan Tolzmann for Kenneth Warren & Son, Ltd.

### TEXT

Dr. Christian Eder  
Johannes Loescher  
Jost Thöne

### LAYOUT & DESIGN

Korhammer Design GmbH

### TRANSLATION

Anna Stuart

### PROOFREADING

Ingbert Edenhofer

### REPRODUCTION & PRINT

Pinsker Druck and Medien GmbH

### PRINTING PRESS MACHINE

Heidelberg HD XL 106-5+L

### PAPER

Maxigloss 170 g/qm from Igepa, produced by UPM

### BINDING

Müller Buchbinderei GmbH Leipzig

### EDITION

First published in May 2016  
Library edition 2000 copies  
De Luxe edition 100 copies

ISBN 978-3-00-050178-4

COPYRIGHT © JOST THÖNE VERLAG 2016

No part of this publication may be reproduced, stored in a retrieval system, or transmitted in any form or by any means, electronic, mechanical, photocopying, recording or otherwise, without prior permission from the copyright owners. All rights reserved.



# Antonius Stradiuarius

*Dedicated to my wife Angelika with Viorica and Titus*

JOST THÖNE

LIBRARY EDITION COPY

/2000



**BRONZE**  
**ANTONIO STRADIVARI**  
*Marijke de Vré-Verlaan*

Some years have passed since we published Volumes I–IV on Antonio Stradivari in 2010, and my team and I have used this time to track down another 152 Stradivari instruments. So now 300 instruments have been depicted and documented, which should amount to roughly two-thirds of the Antonio Stradivari instruments that remain today.

Many owners were ecstatic in offering their support. Still the undertaking was a major effort for all of us once more, and sometimes a good deal of persuasion was necessary in order to obtain some owners' approval for such a publication.

In this context we were especially happy to receive Prof. Anne-Sophie Mutter's approval to include her instrument, the 1710 'Lord Dunraven', in this publication. We gladly catered to her request to use her own photo material in this case. Thus these volumes represent another several steps towards a more complete review of Stradivari's œuvre.

Of course, it remains our goal to depict the complete œuvre and even to capture specific sub-areas. In our research we came across several instruments whose bellies or backs were unfortunately the only remaining original pieces. We decided to round them up in later volumes.

Of specific significance was the contribution of historian Dr. Christian Eder. He was able to add several facts and connections to this publication that had not been discovered before. For instance, the nicknames of several instruments had to be corrected.

Besides the art historical perspective, the technical quality of the instruments was to be described, the level of preservation as well as special features were to be detailed, reductions or incorporations were to be tracked. This task was handled by musicologist and luthier Johannes Loescher in close cooperation with the above-mentioned experts.

Finally I asked John Dilworth to make his essay on Antonio Stradivari's sons available for this publication. Without his sons' devoted cooperation, it is unlikely that Antonio Stradivari could have created such a comprehensive œuvre.



In our present volumes V–VIII we were able once more to make use of the newest technological advances.

With regard to the quality of the pictures we could rely on Jan Röhrmann's expert knowledge again. He used Phase One's top-rated model IQ180 in full format with a resolution of 80 megapixels. This allowed us to document the instrument with even more precision. By means of the unique modular turntable system of 3D-VIZ.com for 360-degree imagery, we were also able to depict the instruments in three dimensions. We had a few examples made and have the results available on our homepage and on the attached DVD.

A special highlight of this publication is the use of dendrochronological study. It is presented in a separate article by our expert Arjan Versteeg. We submitted each instrument to this procedure in order to exclude from this publication any instruments that have obviously been falsely assigned. Fortunately there were only very few cases in which preexisting doubt was corroborated by this method of examination. What occurred more on the basis of this analysis was having to redate instruments to a later year of manufacture; in other cases an earlier date was probable. In addition we also included the instruments from the first four volumes in this examination, leading to encouraging results that support our research. One particular result of this work is the discovery that several instruments come from the same trunk.

Dr. Rudolf Hopfner, Violin Forensic, gave us the opportunity to have several instruments examined by a micro CT scanner at Vienna University. You will find the results and an introduction to this technology both in a separate article and in a video on the attached DVD. We were thoroughly excited by this cooperation. It was like moving through the instrument, which itself was now made of glass, so that even the smallest anomaly of the wood could be traced. I am convinced that this new dimension of assessing instruments will soon be made the standard practice and will reveal to us the last secrets of violin-making of that time.

What is also new to this publication is the auditory element. Both on the homepage and on the DVD you will find sound samples of highly diverse Stradivari instruments. We consciously chose only a few minutes per instrument in order to allow for a comparison of the instruments. We hope to be able to complete this collection with samples of all instruments in the future.

We were introduced to another interesting process by Andrea Michetti, a luthier from Turin. By means of endoscopic examination and the Microtex camera system he showed us an uncomplicated way how to reach the insides of the instruments and to capture the level of their preservation in high-quality videos and pictures. In this way restoration work can be tracked precisely without having to open up or possibly damage the instrument. A selection of our results can also be seen on our homepage and the attached DVD. Here, as well, we hope to extend this resource in the future.

The printing house Pinsker proved to be a company that could master all challenges concerning the printing quality in the best sense of the word. Especially the lengthy process of print approval, which spanned several weeks, was challenging for all persons involved. It is vital, however, in order to ensure the precise colour space of the varnishes and the exact representation of the instruments on paper. Without sensitive and experienced printers as well precise craftsmanship in preparing the printing with the respective colour proofs by Jan Röhrmann, this could not have been done.

To print the documentation we had the world famous quality of HEIDELBERG's newest generation of platesetters and printing machines at our disposal again. It guarantees the best possible realization.



A few years ago two small oil paintings appeared at an auction in Genoa with portraits of Antonio Stradivari and Giuseppe Guarneri del Gesù. At present they are the oldest depictions of the two masters. To express her enthusiasm for these works the sculptor Marijke de Vré Verlaan created a bronze sculpture, which, in turn, served as a template for the artist SAXA to create the word picture that we included in our publication, with the words of Antonio Stradivari's will.

Jost Thöne, Saig, 2016



lo Antonio Stradivari questa voglia chesia la mia voluntà in tanto che la mente è sana e di cor  
 po e di mente subito chesono morto volio che portato in Sancto Dominico e che sia subito detto  
 cinquanta messe sopra il corpo mio comadome francesco mio figliolo lo domado per mio erdi e  
 vollo che sia insieme con catterina mia filiole di mia moglie e Giuseppe e Paolo mio figliolo sin a  
 la morte e chesino a casa di francesco vollo chesia appo la camera dove dormo alla qua  
 si trova catterina mia filiole vollo che resta patrona d'el fructo habia da dare la mita de fructi  
 ad el convento della santissima noncia de san Giorgio Giuseppe resta patrona del  
 fructo che ho sopra la casa del signor francesco poncetti della villeggia de san agata e ma  
 Paolo mio figliolo vollo che sia dato a seimila lire e più se farà mercate vollo che habbia  
 mia moglie e catterina mia filiole e che habbia da godere la casa dove mi vivo e far la parte  
 tanto che rimanga per mia moglie e Paolo mia moglie e Paolo mio figlio quanto vollesse par  
 tire sia dato a me mila lire de debito che ho speso per via di me in Napoli e venire e al  
 tre spese che rimangono per mia moglie e se ne vana di più se farà mercate vollo che  
 ho dato al signor Antonio Basolino vollo che sia di catterina mia filiole e Paolo mio figlio  
 ro in Cremona il 29 January 1729 in Cremona Antonio Stradivari with a sound mind and body  
 and mind fully of his own free will without fraud or force or any other means and immediately fifty  
 masses shall be said over his body and committed to my son Francesco Poncetti in t  
 he parish of San agata and I wish that my son Paolo be given six thousand lire and six more if  
 he will become a merchant I wish that my wife be given her dowry and the clothing that she has  
 and so she shall remain in the house with the other until de  
 ath to my son Alessandro shall be given a capital of five thousand lire to enjoy as long as he  
 lives Francesco must maintain catterina and my wife and they shall have the enjoyment of the  
 house so long as they live and share until either one of them die that is Giuseppe and Paolo shall  
 remain together and to obonimo mercurio shall be given three thousand lire of annuity  
 and to Giovanni Battista Bentivoglio shall be given an annuity of two thousand lire and other e  
 xpenditures and in the house and there is more that shall be divided amongst all of them a  
 nd the one hundred lire that I have to the signor Antonio Basolino I wish that belong to catterina the  
 principal shall as the interest. The 29th January 1729 in Cremona Antonio Stradivari  
 questa voglia chesia la mia voluntà in tanto che la mente è sana e di corpo e di mente. subito C  
 hesono morto volio che portato in Sancto Dominico e chesia subito detto cinquanta messe sopr  
 a il corpo mio comadome francesco mio figliolo lo domado per mio erdi e vollo che sia insieme c  
 on catterina mia filiole mia moglie e Giuseppe e Paolo mio figliolo sin a la morte in questa casa e f  
 rancesco vollo che sia dato a seimila lire e più se farà mercate vollo che habbia da dormire la cam  
 era dove dormo alla qua si trova catterina mia filiole vollo che resta patrona del fructo habia da da  
 re il fructo a la camera di sopra di san agata e ma Paolo mio figliolo vollo che sia dato a seimila lire  
 e più se farà mercate vollo che habbia mia moglie e catterina mia filiole e che habbia da godere la  
 casa dove mi vivo e far la parte tanto che rimanga per mia moglie e Paolo mia moglie e Paolo mio  
 figlio quanto vollesse partire sia dato a me mila lire de debito che ho speso per via di me in Napoli  
 e venire e al tre spese che rimangono per mia moglie e se ne vana di più se farà mercate vollo che  
 ho dato al signor Antonio Basolino vollo che sia di catterina mia filiole e Paolo mio figlio ro in Cre  
 mona il 29 January 1729 in Cremona Antonio Stradivari with a sound mind and body and mind fully  
 of his own free will without fraud or force or any other means and immediately fifty masses shall be  
 said over his body and committed to my son Francesco Poncetti in the parish of San agata and I wish  
 that my son Paolo be given six thousand lire and six more if he will become a merchant I wish that  
 my wife be given her dowry and the clothing that she has and so she shall remain in the house with  
 the other until death to my son Alessandro shall be given a capital of five thousand lire to enjoy as  
 long as he lives Francesco must maintain catterina and my wife and they shall have the enjoyment of  
 the house so long as they live and share until either one of them die that is Giuseppe and Paolo shall  
 remain together and to obonimo mercurio shall be given three thousand lire of annuity and to Giovanni  
 Battista Bentivoglio shall be given an annuity of two thousand lire and other expenditures and in the  
 house and there is more that shall be divided amongst all of them and the one hundred lire that I  
 have to the signor Antonio Basolino I wish that belong to catterina the principal shall as the interest.  
 The 29th January 1729 in Cremona Antonio Stradivari

PORTRAIT  
 ANTONIO STRADIVARI

WORD PAINTING

Copyright by SAXA

Handwritten with Indian ink on canvas

Repro Monika Nonnenmacher

my words turn into pictures—from poetry,

stories, biographies and notes into

multidimensional portraits and images.

# Dendrochronological Study of Stradivari Instruments

## Introduction

### *Dendrochronology and Stringed Instruments*

Dendrochronology, the exact dating of wood, is a long-established science that has become increasingly important in the field of musical instruments. The results of dendrochronological analyses are recognised by experts, dealers and auction houses as a scientific and crucial support for temporal classification. This elegant technique uses observational data and can easily be applied. No destructive sampling is needed. Dendrochronology cannot determine the authenticity of instruments; rather it identifies the 'terminus post quem', the earliest possible building date of the belly of a string instrument. In many cases, however, comparison with the wood of other instruments can reveal additional information about the origin of the instrument and seasoning of the wood.

For this study of Stradivari instruments a selection<sup>1</sup> of the illustrated instruments in volumes I-IV and V-VIII has been analysed, in total 270 instruments. The results offer dendrochronological dates of more than 500 planks and information about the trees from which these planks were cut.

### *Dendrochronology and Stradivari*

Dendrochronological analyses of the instruments of Antonio Stradivari are particularly interesting because of the long and distinguished career of this maker. In the masters' workshop many high quality tonewoods were used to make a great quantity of all kinds of string instruments.<sup>2</sup> The comparison between the woods of these instruments is fascinating, because it sometimes yields a 'same tree connection'. These cross connections can shed light on the working process and the seasoning period of the wood.

## Dendrochronology, Methodology

Dendrochronology is based on analyses of the annual growth-ring width-pattern. The growth of annual rings occurs immediately underneath the bark of the tree, so the outermost annual ring is the most recent, the latest one grown. Seasonal variations cause differences in consistency and colour in the freshly grown wood. The early-spring growth, the early wood, is normally characterised by a lighter shade than the late-summer growth, the late wood. After the winter, in which the growth makes a pause, the growth of the tree resumes, leaving a visible boundary between dark and light shades. Thus in temperate climate zones, where these seasonal variations occur, the age of a tree can be determined by counting the annual rings.<sup>3</sup>

The widths of the rings vary from year to year and from location to location. These variations in ring widths are i.a. caused by, and thus correlated to, variations in the prevailing climatic and environmental conditions. Climatic variation in one region over a number of years results in annual ring-width patterns that are characteristic for those years and region and unique in time. Separate trees in the same region may react differently to the climatic influences to some degree, but their relative ring-width sequences will show a similar pattern.

Some wood species respond more sensitively to climatic conditions than others. Spruce (*Picea abies* (L.) Karsten), which is mostly used for the bellies of string instruments, is sensitive to climatic conditions. The rings of maple (*Acer*)—the wood from which usually back, scroll and ribs are made—are more irregular in growth. The climatic influences are superimposed by other—probably more local-based—influences. Dendrochronological analyses do not reveal reliable results on this species, which is why this study concentrates on the bellies of the string instruments. For this study no microscopic research has been undertaken to determine the precise species used in the fabrication of the bellies. From experience, however, it was assessed that they were made of spruce. For stability, shrinking, warping and acoustical reasons, the planks used to manufacture the belly have been made from narrow grain wood, cut in a radial direction. Cut radially, the annual rings are approximately 90° to the surface of the belly. A distinct boundary between early and late wood can be observed and a precise measurement of ring-width is possible.

Most bellies are made from two pieces of spruce. The youngest annual rings are usually located at the joint.

### *Measurements*

The annual ring-growth is determined by measuring the ring-widths. The measurements were taken from high-resolution images made by Jan Röhrmann. Especially, close-up photographs from f-holes and lower bouts were used.<sup>4</sup>

Since the images were made from instruments with full set-up, some tree-rings might be hidden by strings, fingerboard or tailpiece. In instances

where the grain is not perfectly parallel to the joint, it could be possible that there exist some not-measured annual rings underneath the tail piece or fingerboard.<sup>5</sup>

The ring-width measurements were collected on multiple positions along horizontal axes, so as to minimise erroneous deviations and to calculate a mean value of each ring width.

These ring-width sequences were then graphically and statistically analysed by a specialised software.<sup>6</sup> Graphically the measurement sequences can be plotted on X/Y graphs with the years on the x axis, and the ring-width in mm on the y axis. An example of plotted sequences of the 1714 'Soil' is shown below (Graph 1).

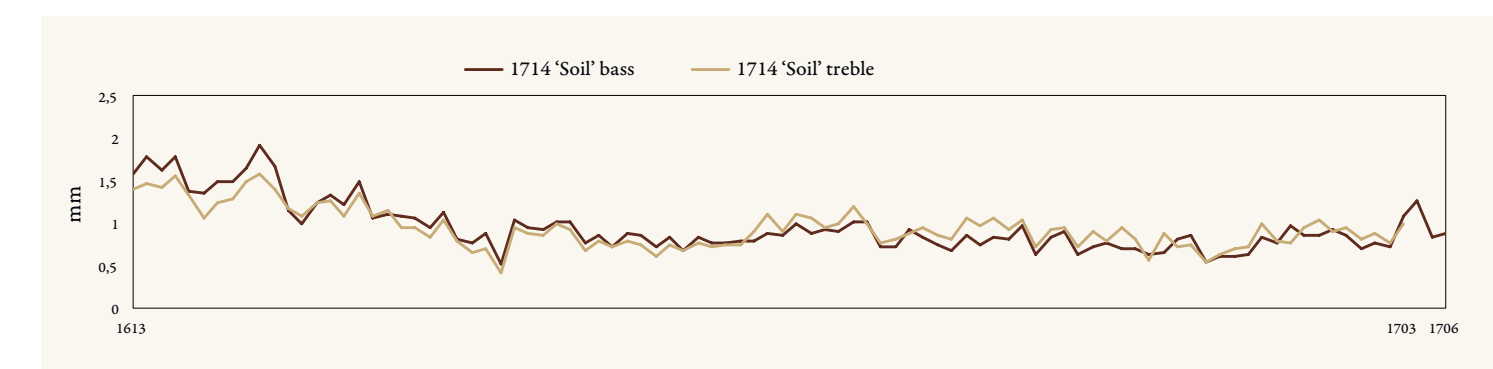

Graph 1:  
1714 'Soil'  
by Antonio Stradivari  
bass- and treble-side

The sequences were statistically compared with a number of spruce reference chronologies<sup>7</sup>, both of instrumental and of non-instrumental origin, including many generously supplied by the International Tree Ring Database (ITRDB)<sup>8</sup> together with the author's comprehensive database (Versteeg-Furnari) of single measurements taken from musical instruments and wooden objects.<sup>9</sup> Additionally chronologies of other coniferous species which grew under similar conditions, such as the larch (*Larix decidua* Mill.), the fir (*Abies alba* Mill.) and the pine (*Pinus cembra* L.), have been compared with the sequences.



Figure 1:  
position of measurements  
Photo: Jan Röhrmann



Figure 2:  
measurement process  
(Both figures: detail of the  
1699 'Auer', 'Benvenuti'  
by Antonio Stradivari)

## CT Scan

### Micro CT Scan | The Foundations

Computed tomography is an imaging technique using X-rays that was originally developed for medical diagnoses. The advantage of this technology is that the entire scanned volume can be captured and, using the resulting data, reconstructed three-dimensionally. Computed tomography is now used routinely in an extensive range of areas of the medical profession. The process has also been used in a modified form for several years in technical fields, in which there is enormous variation in its use with regard to the area to be captured, the resolution and the level of radiation used. High-resolution computed tomography (Micro-CT,  $\mu$ CT) is a specialised area in which a resolution of higher than  $10\ \mu\text{m}$  can be achieved, depending on the size of the object. The machine used by the Core Facility for Micro-Computed Tomography at the University of Vienna for the present examination is able to scan the body of a violin up to a maximum resolution of  $70\ \mu\text{m}$ . For practical reasons, the data has been reconstructed using a voxel size of  $100\ \mu\text{m}$  (a voxel is a pixel in three-dimensional space); the final resolution achieved is therefore 5 to 7 times higher than is possible with medical scanners. The resulting level of detail—and with it, the informative value of the images—is accordingly high.

The starting point for all visualisations is a stack of images in greyscale. To improve clarity, these grey values are assigned false colours. Dense areas appear light, while less dense areas appear dark; thus, air is black, and very dense wood (such as ebony), glue and varnish can appear white. This makes it possible to identify glued areas, whether construction joints or later repairs to the instrument. The software we use has several measurement functions that we were able to employ during this examination. It is possible to take measurements in 2D space (i.e. measuring directly on the slices) or, once a surface model has been rendered, in 3D space. The first method was used to measure the thickness of the wood and the height of the arching. Indeed, our process is so accurate that it can measure the width of the annual rings with the precision required to run a dendrochronological test—even if the wood of the belly has such fine annual rings as those of the present violin. The automated measurement on the 3D surface model was used to produce not only the thickness maps but also the elevation maps.

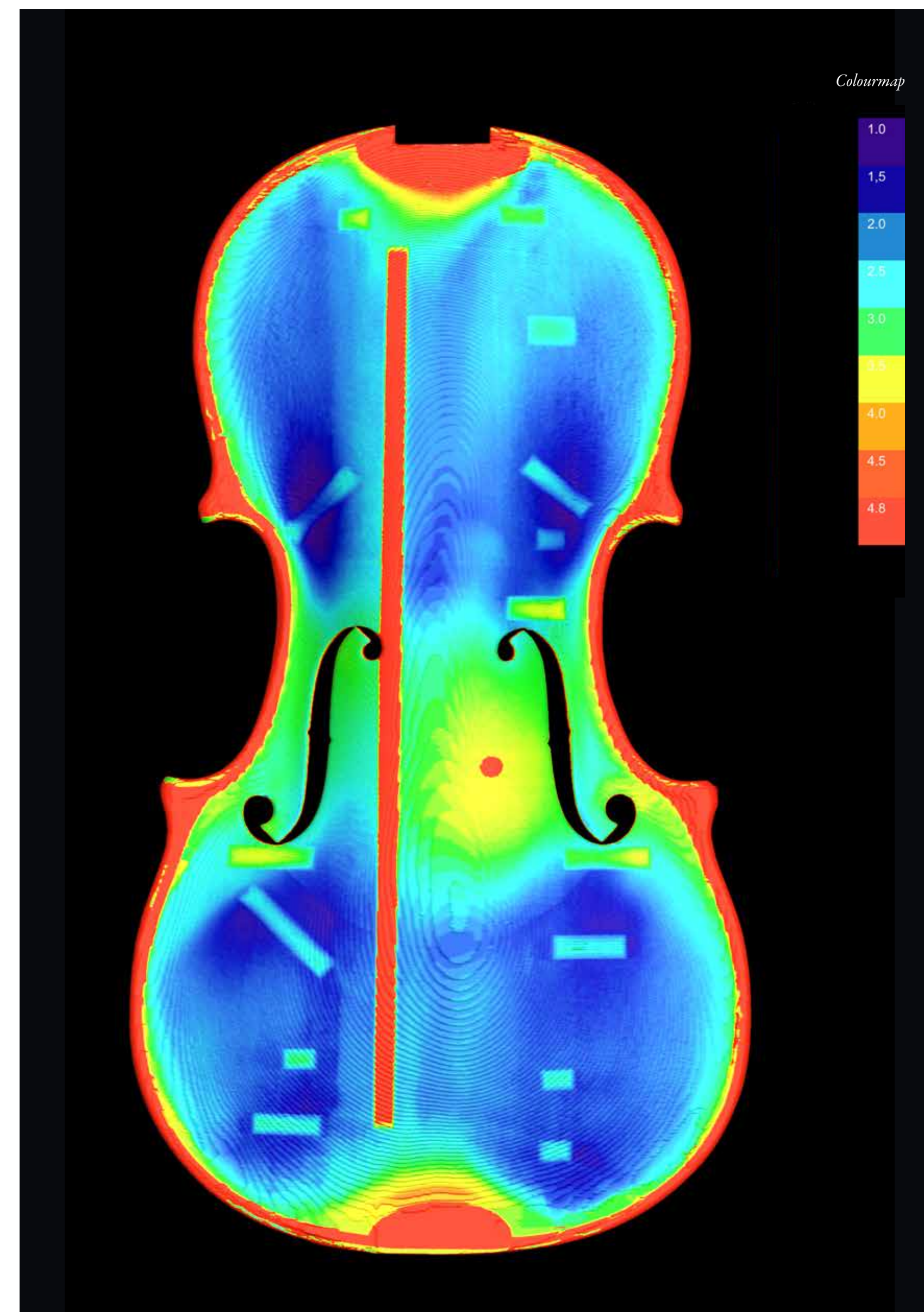
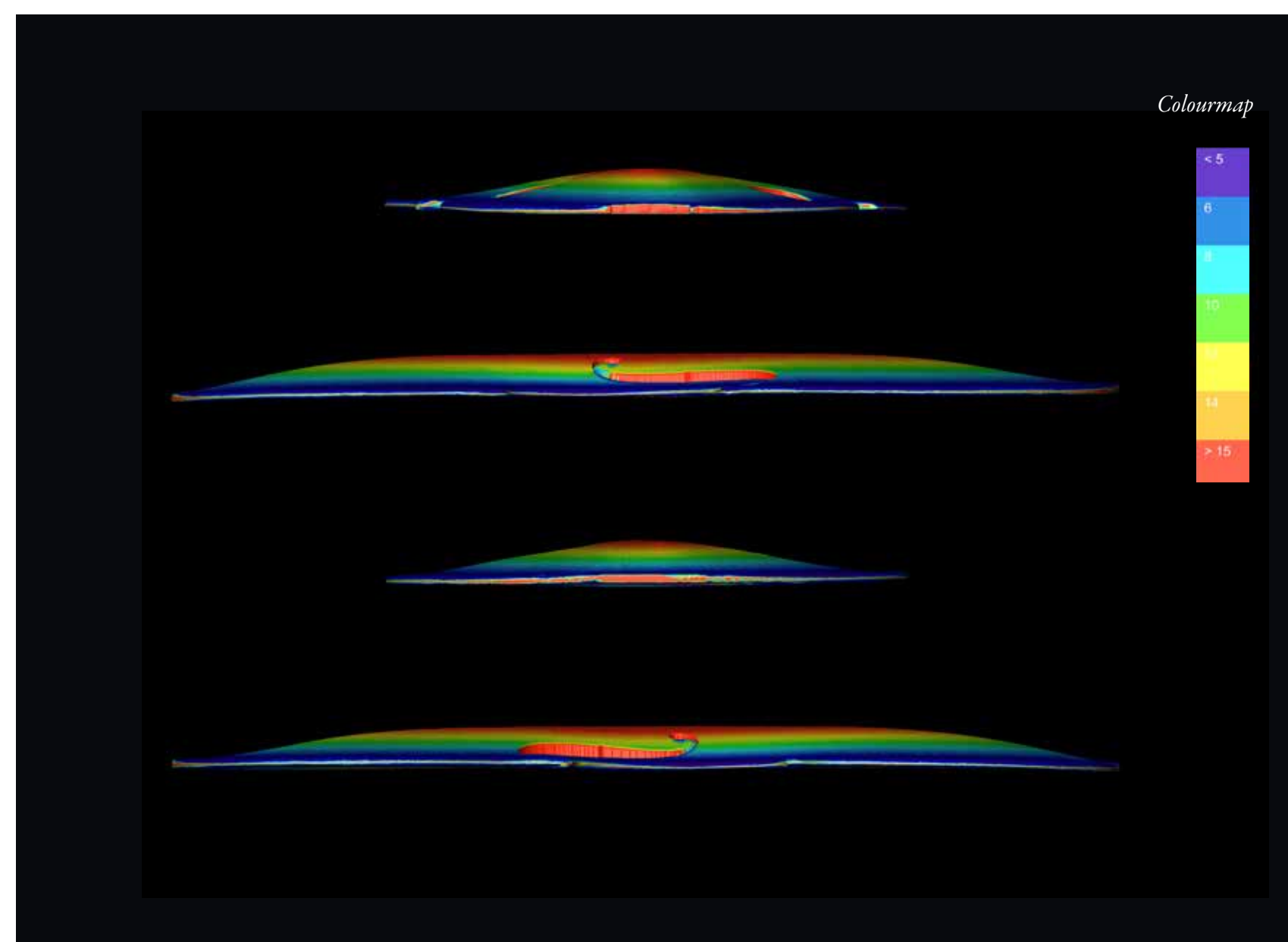



## Violin 1667 Jenkins'

In the year 1667, having just married Francesca Feraboschi, Stradivari set up an atelier in the Casa Nuziale in Cremona. The present violin bears a label from this very year and is thus among the earliest instruments to have been produced by the young luthier in his first independent workshop.<sup>1</sup>

As one would expect, the influence of Amati can be clearly seen in this violin. Interestingly, Stradivari has used a traditional, smaller model that was also used alongside the larger model by other Cremonese violin makers of the Amati school in the mid-17<sup>th</sup> century. With a corpus length of 34.8 cm, it is half a centimetre shorter than another, very similar, Stradivari violin of the same year: the 'Dubois'.<sup>2</sup> The choice of wood for the one-piece back also seems traditional; it has been cut on the slab and has lively, broad flames that are occasionally interrupted by small areas of discolouration or knots. The broadly and variably flamed maple of the scroll and ribs is well matched to the back wood. On the treble side of the ribs, one can see an arrangement that is untypical for Stradivari: the flames in the C-bout run parallel to the neck and scroll, but in the opposite direction to the upper and lower bouts. The violin still has its original neck; however, this has been reset and re-cut. As a result of this alteration, the holes for the three nails that originally held the neck on the body are now visible, although they have since been filled in. The belly, made of hazel spruce, is of choice quality, and the overall craftsmanship is of an extremely high level. The 'Jenkins' was originally covered in a light, golden varnish, which has been somewhat preserved in the C-bouts of the back and in the inaccessible recesses of the scroll and ribs. The early violin has been known among experts since the Hill brothers' publication of 1902; it is listed in Goodkind and is illustrated in the 1999 supplement to Doring. The history of the instrument can be traced back to the turn of the 20<sup>th</sup> century: the earliest known owner was probably Count Cesare Nichesola of Verona, who owned the violin in 1899. It was in that year that the instrument came into the hands of the London dealership William E. Hill & Sons, who sold it in 1902 to a J. Younger. The violin remained in Younger's family until 1947, when it was once more offered for sale at William E. Hill & Sons. It was purchased just a year later by the English violin virtuoso Tom William Jenkins (1910–1957). Jenkins, one of the most noted violinists of his time, had been a pupil of Edward Maude (1880–1967) and performed regularly at the BBC from 1936 onwards. In 1948, on the BBC's request, he took over as leader of the Palm Court Orchestra following the death of Albert Sandler (1906–1948). From then on, the Stradivari was his preferred concert instrument, and it is now accordingly named after him. In 1953 and 1954, at the pinnacle of his career, Jenkins won the National Radio Award for the Most Popular Musical Entertainer. Just few years later, however, the successful musician died unexpectedly in his 46<sup>th</sup> year. The violin passed to his wife, the flautist Michelle Jenkins, to whom he had been married since 1953. In the subsequent decades, the instrument was kept in a bank vault, and it was not until 1995 that Michelle Jenkins decided to sell the violin through Sotheby's.<sup>3</sup> The instrument was accordingly auctioned in London on 20 June 1995, and the highest bidder at £375,000 was an Elisabeth Thomas from Germany, who purchased the violin for her 10-year-old daughter Christina Thomas. Michelle Jenkins donated the proceeds of the sale to the Tom Jenkins Trust, which supports young musicians financially.

By 2008, the violin was once more up for sale, this time at the London dealership John & Arthur Beare. It was purchased in that year by Roger and Huguette Dubois of Drummondville, Canada, who in 2001 had founded the Canimex Foundation, a charitable organisation that provides financial support for musicians and funds concerts. The wealthy couple finally gave the violin over to the Foundation, in whose collection it has remained to this day. The 'Jenkins' is accompanied by certificates from William E. Hill & Sons (1948) and John & Arthur Beare (2008).

<sup>1</sup> Hill, W. Henry / Hill, Arthur F. / Hill, Alfred E., *Antonio Stradivari—His Life and Work (1644–1737)*, Dover Publications, New York, 1902, reprint 1963, p. 35; Doring, Ernest N., *How Many Strads? Our Heritage from the Master*, Bein & Fushi, Chicago, 1945, reprint 1999, p. 369 (ill.); Goodkind, Herbert K., *Violin Iconography of Antonio Stradivari 1644–1737*, Larchmont, New York, 1972, p. 725; Pigaillem, Henri, *Stradivarius—Sa vie—Ses instruments*, Zurich, Bourg-la-Reine, 2000, p. 135.

<sup>2</sup> Interestingly, both violins were at one time simultaneously in the possession of Roger and Huguette Dubois in Canada.

<sup>3</sup> Sotheby's Musical Instruments Auction Catalogue, 20 June 1995, Sotheby's, London, 1995, Lot 34.









## Guitar 1679 'Sabionari'

The 'Sabionari' guitar, completed in 1679, is one of five extant baroque guitars made by Antonio Stradivari. It is currently in the possession of a private owner and is exhibited at the Museo del Violino in Cremona, Italy. A letter written in 1854 by the guitar's then owner, the art dealer Filippo Benetti of Ferrara, to a new buyer, the Bolognese landowner Vincenzo Tioli, still survives. According to this letter, which provides information about the whereabouts of the instrument in the 18<sup>th</sup>- and 19<sup>th</sup>-centuries, Benetti purchased the guitar from Giovanni Sabionari (after whom the instrument is now named), who had acquired it directly from a descendant of the Stradivari family, although the date of this sale is not given. In 1997, the researcher Gianpaolo Gregori published a study presenting the history and a comparative organological analysis of the five remaining Stradivari guitars, including the 'Sabionari'.<sup>1</sup> He described the whereabouts of the instrument following its sale in 1854: in 1888, the guitar was in the hands of a new owner, F. Donati, who exhibited it at the International Exhibition of Musical Instruments in Bologna. The exhibition's technical commissioner was the luthier Giuseppe Fiorini, and its honorary president was Giuseppe Verdi. Sometime between 1935 and 1945, the guitar was sold in Bologna by the dealer G. Bagnoli to its current owners, who took it to the 10<sup>th</sup> Guitar Convention in Bologna on 5 December 1948 and showed it to Andrés Segovia. Segovia examined the guitar thoroughly and decided to place his signature on the inside of the instrument, directly beneath the sound hole: 'Due secoli più tarde, A. Segovia Bologna 1948'. With 'two centuries later', he was presumably referring to Stradivari's death.

In 1984, the 'Sabionari' was displayed at the exhibition 'Luomo e il legno' in Milan, and the exhibition's technical commissioner, Bruce Carlson, invited Gianpaolo Gregori to examine the guitar. Stewart Pollens, former Conservator of Musical Instruments at the Metropolitan Museum of Art in New York, included a chapter on Stradivari guitars in his 2010 book 'Stradivari', in which he described the 'Sabionari' before its restoration in 2011.<sup>2</sup> At the end of 2010, the current owners entrusted French luthiers and restorers Sinier de Ridder with the guitar's restoration. Since none of the other remaining Stradivari guitars was in playing condition, no one in the modern world had ever heard the sound of these instruments. On 27 April 2011, the 'Sabionari' was exhibited at the Fabre Museum in Montpellier, where Sinier de Ridder gave a lecture about the restoration process, and the guitar was heard for the first time in a performance by the guitarist Krishnasol Jiménez Moreno. In March 2012, Sinier de Ridder produced a certificate of authenticity for the instrument.

On 9 June 2012, 333 years after it was made, the 'Sabionari' returned to Cremona and was entrusted to the Fondazione Museo del Violino Antonio Stradivari; it is currently exhibited as part of the 'Friends of Stradivari' collection at the Museo del Violino. The museum's conservator, Fausto Cacciatori, described the guitar in an article published in the supplement to the September 2013 issue of *The Strad* magazine.

In June and September 2012, Krishnasol Jiménez Moreno made the first recording of the 'Sabionari' guitar, performing works published by Robert de Visée in Paris in 1682.<sup>3</sup> He notes: 'Recording a CD with an instrument which has not been played for at least 200 years, and which has been restored, already constitutes a challenge. In addition, no recording has been made with one of Stradivari's guitars to date; all this made for an exhilarating experience. Just as the music of de Visée shows itself to be a fountain of knowledge, a deepened engagement with an instrument of his times enriches our understanding of the art of interpretation. The way in which a specific sound is produced, the phrasing of the musical text, and finding a suitable fingering are directly influenced by the instrument. In this sense I found an exceptional master in the "Sabionari" guitar.'

On 10 May 2014, Gianpaolo Gregori, Fausto Cacciatori, Lorenzo Frignani and guitarist Rolf Lislevand participated in a lecture at the Museo del Violino in Cremona entitled 'Stradivari Costruttore di chitarre, la Sabionari del 1679'. That evening, Lislevand performed on the 'Sabionari' in a concert; he described the guitar as follows: 'This instrument has an incredible balance of the two parameters, attack and resonance, never heard so far. I have chosen to bring music almost never played: Italian operas from the first half of the 1600s [...]. Playing it on a modern copy of a baroque guitar [...] did not give me the feeling of having understood. With a guitar of this quality, this music is miraculously reborn.'

From January to April 2015, the 'Sabionari' was displayed at the HMB—Museum für Musik in Basel as part of its exhibition 'GUITARORAMA—Guitars from Stradivari to Stratocaster'. The guitar was also presented at a lecture by Sinier de Ridder and in a concert by Krishnasol Jiménez Moreno at the Musik-Akademie Basel. In June 2015, Jiménez Moreno recorded a new CD/Bluray disc in the auditorium of the Museo del Violino in Cremona, playing music by Angelo Michele Bartolotti from around 1656.<sup>4</sup>

Roberto Domenichini

<sup>1</sup> Gregori, Gianpaolo, 'La harpe e le guitares d'Antonio Stradivarius', in *L. Nouveaux timbres, nouvelle sensibilité au XVIIIe siècle*, French National Centre for Scientific Research, 1997.

<sup>2</sup> Pollens, Stewart, *Stradivari*, Cambridge University Press, Cambridge, 2010.

<sup>3</sup> Brilliant Classics, CAT NUMER 94435, EAN CODE 5028421944357.

<sup>4</sup> CD/Blu-ray disc produced by Bmn-médien, ASIN: B00ZJRIRZ4.





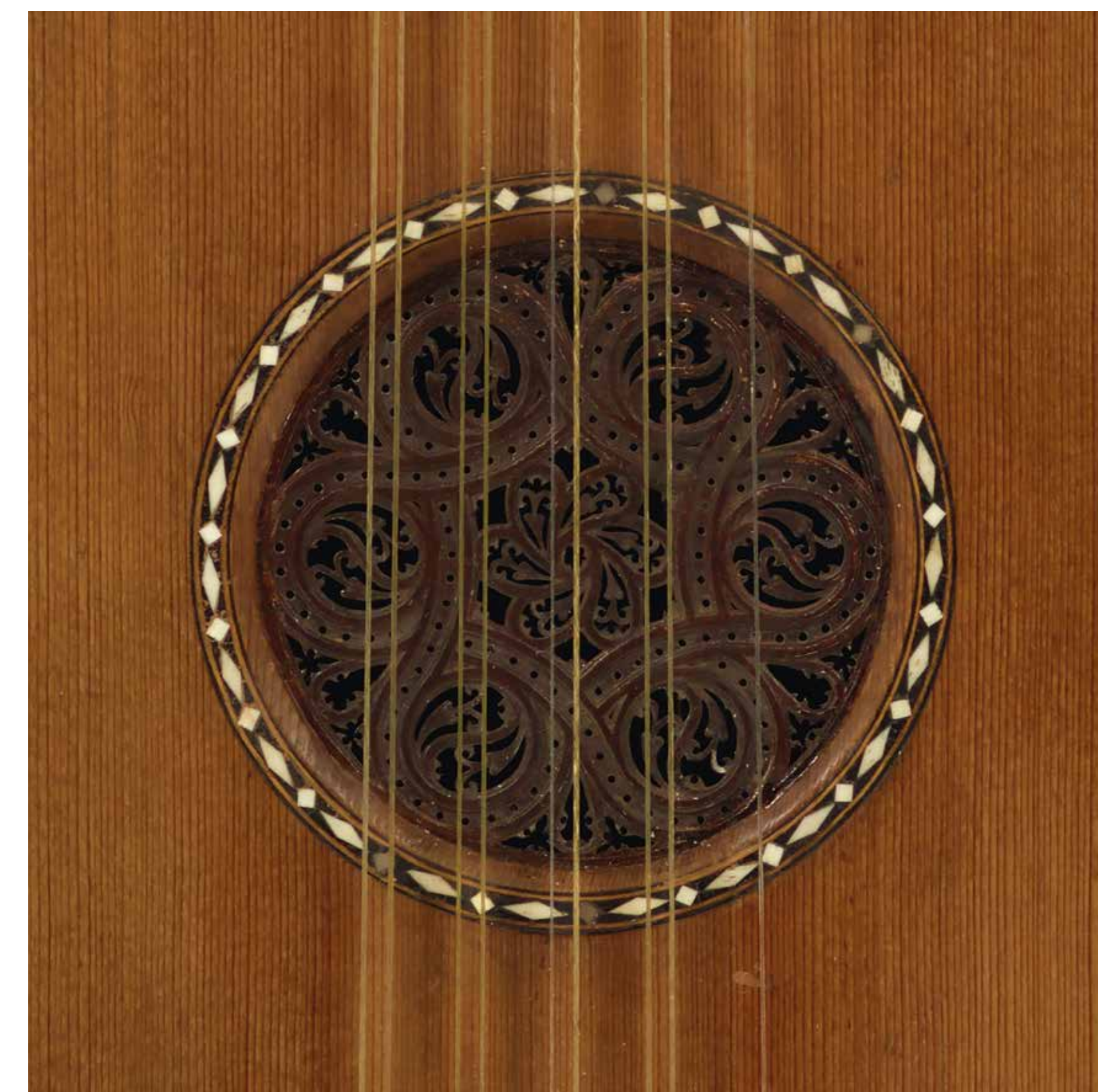

## Cello 1689 'Archinto'

Undoubtedly one of Antonio Stradivari's most famous instruments, this cello of 1689 is listed and discussed in detail in all of the standard literature. Like the 'Mediceo' cello of 1690, the 'Archinto' is remarkable for its excellent overall condition; indeed, the two are surely among the most impressive bass instruments to have been produced by Stradivari in the 17<sup>th</sup> century. The present instrument was also one of the largest cellos built by the master before 1700, although it was shortened in the 18<sup>th</sup> or 19<sup>th</sup> century.<sup>1</sup>

The spectacularly narrowly, deeply and regularly flamed maple of the 'Archinto' is another quality it shares with the 'Mediceo' and is one that is rarely seen in large instruments of the 17<sup>th</sup> century; the two cellos are indeed so similar that one could quite believe them to have been cut from the same trunk. The instruments are further related through the chronological proximity of their production and were also both made for clients in Florence who were presumably connected with one another politically. A comparison of the corpus shape reveals that the cellos were both made using the same mould (sadly no longer available in its original form). The body of the 'Mediceo' was fortunately not reduced in size and thus remains in its original perfect proportions to this day. The alteration to the 'Archinto' seems to have taken place fairly early on; John Dilworth refers to a diary entry written by Count Cozio di Salabue in 1816, in which the latter mentions the successful reduction of the instrument and conjectures that the work was carried out by the Mantegazza Brothers of Milan.<sup>2</sup> The setup of the body to accommodate the demands of contemporary players has been executed unobtrusively and with great care—something that is sadly not true of most of the other instruments to have been considered 'too large' and reduced in size. In order to reduce the mensur of the 'Archinto' to modern dimensions its upper bout has been shortened, while the body of the instrument has been made slightly more slender through the removal of a thin strip of wood at the middle joint on the belly and back. The outer contours of the lower bout and waist thus remain untouched; the alteration of the original proportions is only noticeable from the middle of the upper bout onwards. Thanks to this fairly cautious intervention, the original arching has been largely preserved, displaying the beautiful deep, wide sweep of the fluting, which is still heavily influenced by the Amati school.

The unsurpassable care in the shaping of the corners and edges, the sculpting of the scroll and the cut of the f-holes are also evidence of the particular importance that this commission must have had for Stradivari. Together with the wonderful, still plentiful dark red-brown varnish, the condition of the 'Archinto' provides a very comprehensive impression of the master's work at the height of his technical and artistic abilities.

It is generally believed that Stradivari made the cello for the Cardinal (later Archbishop) of Milan, Giuseppe Archinto (1651–1712)<sup>3</sup>, although this is not supported by any documentary evidence. What is certain, however, is that the instrument was in the possession of Count Giuseppe Archinto (1783–1861)—a descendant of the artistically-minded Cardinal—in around 1850 and was part of a quartet of Stradivari instruments in his collection. Following the death of Archinto, the cello was purchased in around 1862/1864 by the collector Gustavo Adolfo Noseda (1837–1866)<sup>4</sup>; however, in around 1865 he soon passed it on to the French luthier and dealer Jean Baptiste Vuillaume (1798–1875), who had already purchased the other instruments from Archinto's estate. Vuillaume sold the instrument shortly afterwards to Charles Wilmotte in Antwerp, who in turn sold it to the Parisian amateur cellist and passionate collector Abel Bonjour (†1886).<sup>5</sup> Shortly before his death, Bonjour loaned the cello out to the 1885 South Kensington Exhibition. Following his death, the nine cellos in his collection were put up for auction at Hôtel Drouot in Paris on 5 February 1887. The 'Archinto' cello was finally secured by the French cellist Jules Delsart (1844–1900) for the price of 19,000 French francs, following a tight bidding war against William Ebsworth Hill (1817–1895).<sup>6</sup> The wealthy Delsart was at the pinnacle of his musical career at this time and enjoying success with a number of string quartets. The 'Archinto' was Delsart's preferred concert instrument until his death, and the fine tone of the instrument attributed to its owner's renown. Following Delsart's death, his widow kept the instrument for a number of years before selling it in January 1907 for 30,000 French francs to a consortium of dealers consisting of Hill & Sons, Caressa and Maucotel. The two French dealers were soon able to find a new prospective buyer for the exceptional instrument, and they sold it in July 1907 to an amateur cellist from Marseille named Monsieur Gailhard.<sup>7</sup> In 1915, against the backdrop of the First World War, Gailhard tried to sell the cello on for profit through Maucotel. The dealer sold it in October 1915 to Lucien Sharpe of Massachusetts for 80,000 French francs, and the instrument thus found its way from Europe to America.<sup>8</sup>

In the early 1920s, the instrument came into the possession of the wealthy manufacturer Russell Barclay Kingman (1884–1959) of New Jersey, who publicised it shortly afterwards.<sup>9</sup> This enthusiastic amateur cellist, who even made a number of recordings, played in the New Jersey Symphony Orchestra and was its president from 1928 to 1936. In the course of 1932, he presented the cello to all the renowned dealers in America and Europe, requesting reports on the authenticity and history of the instrument. This sudden, lively demand for certificates was precipitated by the planned sale of the cello, which subsequently took place through Rudolph Wurlitzer Co. in New York on 11 January 1937.<sup>10</sup> The buyer was John Nicholas Brown II (1900–1979) from Providence, Rhode Island. An art-loving philanthropist, John Nicholas Brown was a member of the wealthy Brown family, who were among the founders of Brown University. Following the Second World War, Brown, who was a high-ranking member of the United States Army, worked as a Special Cultural Advisor for the 'Monuments, Fine Arts and Archives Program' in war-ravaged Germany. The amateur cellist did not only play on the 'Archinto' himself, but also lent it to prominent musicians, such as the Russian cellist Raya Garbousova.<sup>11</sup> In July 1960, Brown sold the instrument through Rembert Wurlitzer in New York to Walter Lagemann of Rowayton, Connecticut.<sup>12</sup> This rich traveller and collector owned the cello until 1974, when he donated it to the Music Academy of the West in Santa Barbara, California.<sup>13</sup> The Academy sold it on 18 August 1976 for \$200,000 to Richard D. Colburn (1911–2004), a million-dollar businessman and untiring patron of music.<sup>14</sup> The instrument thus became part of the Richard D. Colburn Foundation, whose main area of support continues to be in classical music education. In 2008, the cello was sold by the foundation through the dealership Robertson & Sons of Albuquerque, New Mexico, to its current owner, a doctor from Texas.<sup>15</sup>

<sup>1</sup> The instrument is described in detail in Dilworth, John, 'Antonio Stradivari Archinto Cello 1689', *Usk Publishing Limited, London, 2014*.

<sup>2</sup> Dilworth, *op. cit.*, p. 18. In the certificate produced by the London dealership William E. Hill & Sons for Russell B. Kingman on 11 April 1932 (p. 2), the alteration is still attributed to Jean Baptiste Vuillaume.

<sup>3</sup> See, for example, Doring, Ernest N., 'How Many Strads? Our Heritage from the Master', *Bein & Fushi, Chicago, 1945, reprint 1999*, pp. 65–67.

<sup>4</sup> Letter from Hill to Russell B. Kingman, 11 April 1932, p. 1.

<sup>5</sup> Dilworth, *op. cit.*, p. 9.

<sup>6</sup> Letter from Hill to Russell B. Kingman, 11 April 1932, p. 1.

<sup>7</sup> Letter from Hill to Russell B. Kingman, 11 April 1932, p. 2; certificate produced for Russell B. Kingman by Albert Caressa Succ., 25 July 1932.

<sup>8</sup> Sales receipt from Silvestre & Maucotel, 30 October 1915.

<sup>9</sup> Kingman, Russell Barclay, 'The "Archinto" Violoncello—Antonius Stradivarius, Cremona, 1689', *A.W. Elson, c.1925*.

<sup>10</sup> Certificate and sales receipt for John Nicholas Brown from Rudolph Wurlitzer Co., 11 January 1937; Doring, Ernest N., 'The "Archinto"', *Violins 1, Number 3, 1938*, p. 96, fig. p. 86.

<sup>11</sup> See Dilworth, *op. cit.*, p. 11.

<sup>12</sup> Certificate and sales receipt for Walter Lagemann from Rembert Wurlitzer, 23 June 1960.

<sup>13</sup> Written transfer of ownership from Walter Lagemann to the Music Academy of the West, 17 December 1974.

<sup>14</sup> Certificate of sale and transfer of ownership from the Music Academy of the West to the Richard D. Colburn Foundation, 18 August 1976.

<sup>15</sup> *The Robertson Collection, Albuquerque, 2009*, p. 6 (supplement, 'The Strad', May 2009).











## Viola 1690 'Medicea'

This famous large viola, which has been given the name 'Medicea 1690', is the only instrument made by Antonio Stradivari to have survived in its original condition. Indeed, the viola looks exactly as it would have done when it left the master's workshop 325 years ago; even the tailpiece and the fingerboard, inlaid with mother-of-pearl, remain intact. Furthermore, some of the drafts for the instrument have been kept, including a sketch indicating the positioning of the f-holes.<sup>1</sup> The instrument was one of two violas commissioned by the heir to the throne of Tuscany, Ferdinando de' Medici (1663–1713), to complete a Stradivari 'quinter'. Following the delivery of two violins and a cello in the first half of 1690, a second order was placed by the Florentine court in the autumn of that year, as noted by Stradivari on 4 October 1690 on one of his drafts.<sup>2</sup> The two violas were delivered in the winter of the same year.

The exceptional condition of the viola can, of course, be largely attributed to its status as part of the Medici collection; however, it is also a result of the fact that the instrument went out of fashion shortly after its production and was thus no longer used. In the 17<sup>th</sup> century, the tenor viola certainly played an important role in five-part string writing, which, apart from the combination of two violins and bass, was the predominant instrumentation for polyphonic violin music at the time. In the course of the 18<sup>th</sup> century, however, the style of composition changed, and four-part writing—using two violins, a smaller viola and a smaller cello—became the norm: our 'classic' string quartet.

Since virtually nothing on the present viola has been changed, a number of very interesting details can be observed. The back button and the end of the pegbox correspond to one another in their form and size—a concept whose aesthetic was later abandoned in the frequent alterations to the form of the neck, during which the heel was reduced to increase playability, and which is thus very rarely to be found on old instruments. The original narrow saddle is simply a continuation of the top edge but made of a harder wood and is thus inconspicuously and harmoniously integrated into the overall appearance of the corpus. Since the saddle ends below the protective purfling, the risk of it restricting the belly wood and causing cracks is greatly reduced; indeed, modern saddles that interrupt the purfling can often be the cause of serious damage. On the pegbox and scroll, where the blackening of the chamfers is still well preserved, a distinctive feature can be seen: the middle line on the back of the pegbox and the outer windings of the scroll have also been unobtrusively blackened, emphasising the precision of the carving. In the centre of the end of the pegbox, which in this case is circular, the hole made by the point of the compass used to mark the outline is still clearly visible.

The dendrochronological examination reveals that the wood used for the viola's belly had not been stored for very long; the youngest discernable growth rings on the two halves date from 1682 and 1683. Incidentally, the belly wood has also been shown to originate from the same trunk as that of the 1696 'Archinto' viola. All in all, with their similar markings and the same high quality of the wood, the Medici instruments certainly seem to have been produced as a whole unit. The viola's almost completely preserved golden brown varnish appears considerably lighter than that of the violoncello.

In the first complete inventory of the musical instrument collection at the Florentine court in Palazzo Pitti, compiled in 1700 by the court instrument maker Bartolomeo Cristofori (1655–1731), the present viola and its counterpart are discussed in detail. The two instruments are also listed in the subsequent palace inventories of 1716 and 1762. In the autumn of 1762, both violas were given to the court composer Eugène, Marquis de Ligniville (1730–1788). This is verified by an entry in the court log book on 16 October 1762. However, on the date of return (5 October 1776) only the present viola was documented, while the other instrument had somehow mysteriously vanished. Indeed, in the inventories of 1777, 1786 and 1819 it is only the present viola that is listed, with no mention of its counterpart. Between 1823 and 1829, the instrument was serviced and cleaned twice by the luthier Arcangelo Bimbi, who was employed at the Florentine court—by then occupied by the Habsburgs. In 1843 and 1845, the violin maker Gaetano Piattellini cleaned the viola and carried out some minor repairs on the tail-gut. Following the flight of Grand Duke Ferdinand IV (1859–1860) and the assimilation of the Grand Duchy of Tuscany into the Kingdom of Italy in 1861, a thorough inventory of the Palazzo Pitti was compiled, in which the viola was listed for the last time. In 1863, the instrument was finally given to the Regio Istituto Musicale di Firenze, which had been founded in 1860. This institution was the forerunner of the Conservatorio di Musica 'Luigi Cherubini', in whose collection the viola has remained to this day. The instrument was discussed at length by Hill in 1902<sup>3</sup> and was displayed at the exhibition in Cremona in 1937. It was later listed by Doring and Goodkind<sup>4</sup> and was presented in Cremona again in 1987.<sup>5</sup> In 2001, the viola was finally publicised with all the available archival sources for the first time.<sup>6</sup>



<sup>1</sup> Beare, Charles / Carlson, Bruce, *Antonio Stradivari: The Cremona Exhibition of 1987*, J. & A. Beare Ltd., London, 1993, p. 89 (ill.).

<sup>2</sup> Hill, W. Henry / Hill, Arthur F. / Hill, Alfred E., *Antonio Stradivari—His Life and Work (1644–1737)*, Dover Publications, New York, 1902, reprint 1963, p. 223.

<sup>3</sup> Hill / Hill / Hill, *op.cit.*, pp. 97–99.

<sup>4</sup> Doring, Ernest N., *How Many Strads? Our Heritage from the Master*, Bein & Fushi, Chicago, 1945, reprint 1999, pp. 69–71 (summary of all instruments); Goodkind, Herbert K., *Violin Iconography of Antonio Stradivari 1644–1737*, Larchmont, New York, 1972, p. 224 (ill.), p. 723.

<sup>5</sup> Beare, *op.cit.*, pp. 82–89.

<sup>6</sup> Falletti, Franca / Meucci, Renato (ed.), *La collezione granducale del Conservatorio Cherubini*, Exhibition catalogue, *La Musica alla Corte dei Granducchi*, Galleria dell'Accademia di Firenze, 28 maggio all 11 novembre 2001, *La musica e I suoi strumenti 1*, Giunti, Firenze, 2001, pp. 144–148 (includes a list of the earlier literature).





## Acknowledgements

First of all I am grateful here to my wife Angelika Wied-Thöne and my six children, who have encouraged and supported me indefatigably, not only during all stages of this documentation.

I also want to thank my two eldest sons Jonas and Claudius, who assisted me tremendously with their knowledge and their spirit both with the organization beforehand and with the production itself.

*We are especially grateful to several supporters, who deserve special mention:*

### JAN RÖHRMANN

*who I have worked closely with for over two decades now, has supported me again in a great and highly professional manner while working on these supplementary volumes. He went out of his way and travelled even to the most distant locations to take photographs of instruments for this publication.*

### MARÉN KORHAMMER

*We had already received perfect support in the production of the first four volumes by Marén Korhammer and her design agency Korhammer Design GmbH. It is a special challenge to embed all those many results and levels into the complete layout and have it look as if made from one piece. I am grateful for her support that is always professional and personal at the same time as well as for her motivational influence on the whole team.*

### JOHANNES LOESCHER

*Musicologist and luthier Johannes Loescher was a big help describing all the instruments regarding Stradivari's working phases. He also concentrated on pointing out some special anomalies of several instruments.*

### GERD FASSBENDER

*The digital expansion to include the website [www.stradivaribooks.com](http://www.stradivaribooks.com) was made possible in cooperation with Gerd Fassbender, who is responsible for all IT tasks. This is a decisive step into the modern shape of a printed documentation. Should any documents appear only after printing, we are able to add them to the 300 shown instruments at any time. Interior photos, audio and video samples, CT images, certificates, restorations, changes of soloists and owners can all be documented in a manner adequate for our era now.*

### MARCO RÖMISCH

*was of immense help to me in the complex organisation of the project and as a consultant, as well as the marketing of the project, a supervision in its own league that helped me make many important decisions and will continue to do so.*

### SEAN CARPENTER

*The firm Carpenter Fine Violins LLC, especially represented by Sean Carpenter, significantly supported our work in the USA. It is due to him that we were allowed once more to incorporate a large amount of instruments that are located in the USA. What is more, Sean Carpenter has also contributed some of the instruments' biographies, for which I am deeply indebted.*

### ANNA STUART

*supported the project as a native speaker with linguistic sensitivity and the knowledge necessary for this often complex and delicate subject matter.*

### INGBERT EDENHOFER

*The documentation was copy-edited by him, who had already done outstanding work on the first four volumes.*

### CLAUDIA DEWAR

*The sensitive collection and proofing of the measurements of each instrument on the DVD was conducted by Claudia Dewar. She also organised the audio samples and assisted with all aspects of coordination.*

### DR. JOACHIM A. GROTH

*Finally Dr. Joachim A. Groth again took care of filling one or another expert with enthusiasm for our project and eventually raising funds. For this, as well, I am deeply grateful.*

*I am also grateful to many colleagues for their support in the form of granting us access to their studios for photo shoots as well as local organisation in manifold ways. These include:*

### USA/CANADA

David Brewer Fine Violins LLC and Erin Brewer  
Roger und Daniel Dubois/Canimex Inc.  
Ric Heint/Geo. Heint & Company Ltd.  
Christophe Landon Rare Violins NYC  
Rare Violins of New York  
David Seagal Violins Ltd.  
Tarisio London & NYC  
The Cozio-Archive

### ASIA

Muneyuki Nakasawa  
Dai-Ting  
Ricci Inagaki

### EUROPE

J&A Beare Ltd.  
Florian Leonhard Fine Violins  
Sean Bishop Violins  
Stephan von Baehr  
Balthazar Soulier  
Frédéric & Lucie Chaudière  
Johannes G. Leuthold  
Roland Baumgartner  
Jürg Buchwalder  
Michael Zuber  
Matthias Beimdiek  
Jens Stenz  
Jens G. Johansson

*A publication like this cannot be accomplished without the friendly support of the most important collections and museums worldwide:*

Accademia Nazionale di Santa Cecilia, Rome  
Ashmolean Museum, Oxford  
Canada Council for the Arts, Toronto  
Canimex, Drummondville  
Chi Mei Culture Foundation, Tainan  
Finnish Cultural Foundation, Helsinki  
Galleria degli Uffizi, Florence  
Glinka National Museum Consortium of Musical Culture, Moscow

LBBW Musikstiftung, Stuttgart  
Munetsugu Collection, Tokyo  
Musée de la Cité, Paris  
Museo del Violino, Cremona  
National Museum-Czech Museum of Music, Prag  
Royal Academy of Music, London  
UNIARTS-Sibelius Academy, Helsinki

*Naming the following partners and friends is the least I can do to express my gratitude towards them:*

Giovanni Accornero  
Paul Barter  
Peter Biddulph  
Dylan Blackmore  
Paolo Bodini  
David Brewer  
Philippe Brugièrè  
Burg Services GmbH  
Fausto Cacciatori  
Alfredo Clemente  
Charles Coquet  
Michael Darnton  
Roberto Domenichini

Vera Domik  
Philippe Echard  
Klaus Fassbender Consulting GmbH  
Jean Fitzgerald  
Andrea Frandsen  
Dmitri Gindin  
Stefan-Peter Greiner  
Wolfgang Hamberger  
Jay Ifshin  
Ingles & Hayday  
Beate Kienitz  
Florian Leonhard  
Andy Lim

Lüder Machold  
Meta4 Quartett  
Nippon Violin Co. Ltd.  
Andreas Nonn  
OENB/Marguerite Kurz  
Horst Pinsker  
Jason Price  
Claudia Prutscher  
Martin Radford  
Christian Reister  
Wolfgang Reithmaier  
Marcel Richters  
Duane Rosengard

Naomi Sadler  
Sebastian Skarp  
Nathan Tolzmann  
Francesco Toto  
Virginia Villa  
Violin Assets GmbH  
Kenneth Warren & Son, Ltd.  
Gerhard Wieser  
Wilder & Davis  
Janine Wildhage

All private owners, foundations and banks that are not listed individually and many more ...



# Antonius Stradiuarius

*Book Samples*

*DVD Samples*

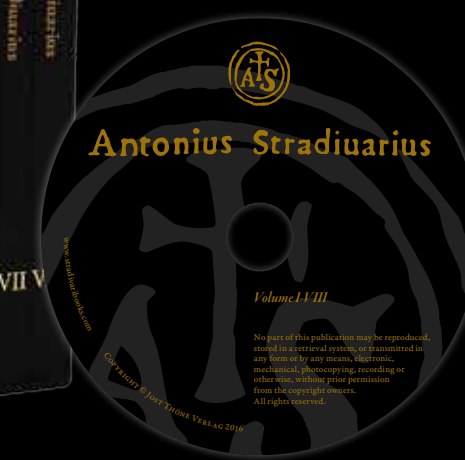
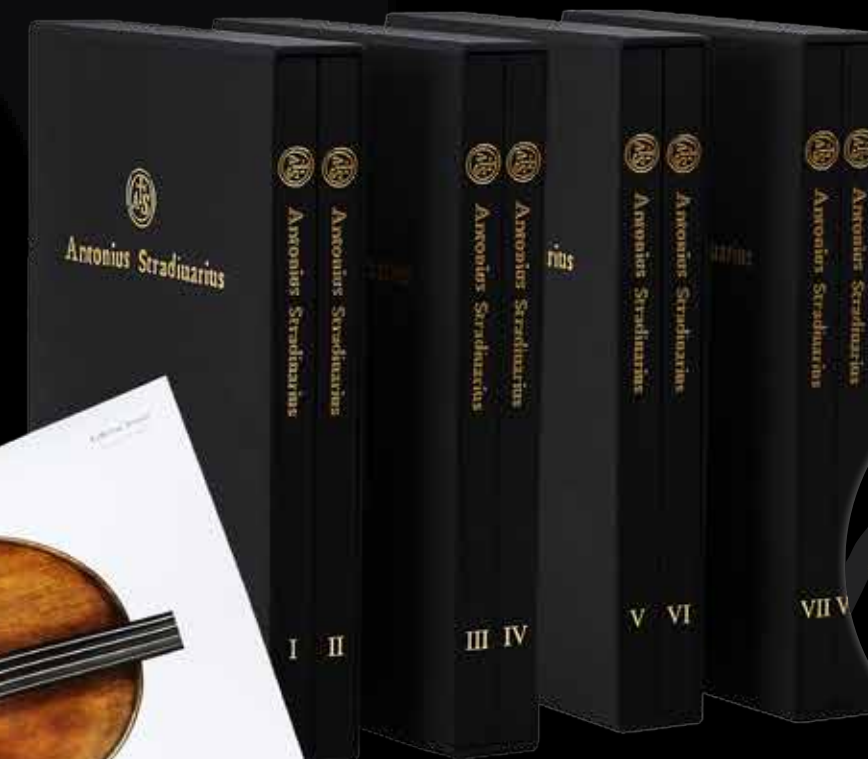





# Antonius Stradiuarius

*Dendrochronology*

---

*Vol I-VIII*

---

*Music*

---

*CT-Scans*

---

*360° Turns*

---

## *Results of the Dendrochronological Analyses of Stradivari Instruments*

The results of the dendrochronological analyses of the instruments of Volume I–VIII are listed in the following table. They are ordered chronologically by the attributed manufacturing dates of the instruments. The dendrochronological dates of the bass and treble sides of the single instruments are listed in a column.

In cases of one-piece bellies only one date is itemised. Graphically, the difference between the manufacturing date and the dendrochronological date is illustrated by the golden bar. The golden bar displays the seasoning period plus the number of annual rings cut before making the joint. The ‘oldest’ annual rings measured—which are usually located near the inlay—are also depicted. This way the number of measured rings can be perceived.

The measurement was taken on multiple positions along horizontal axes at a 90-degree angle to the grain. These positions include the lower bout, the widest part of the belly. The measurements were taken within the inlay—without the edges, since they can be renewed during a restoration.



*Figure 1:  
measurement positions  
lower bout of  
the 1690 ‘Stephens’,  
photo: Jan Röhrmann*



*and  
measurement positions  
detail f-hole of  
the 1690 ‘Stephens’,  
photo: Jan Röhrmann*

*Dendrochronological study on Stradivari instruments*

<i>Manufacturing date</i>	<i>Dendrochronological date</i>	<i>1430</i>	<i>1480</i>	<i>1530</i>	<i>1580</i>	<i>1630</i>	<i>1680</i>	<i>1730</i>	<i>Book/Page</i>
c.1667 'Aranyi' violin	T one piece top 1651	1471				1651	1667		I/32
1667 'Dubois' violin *	bass 1653			1547		1653	1667		V/36
	treble 1650			1546		1650	1667		
1667 'Jenkins' violin *	bass 1610		1520		1610		1667		V/44
	treble 1610		1522		1610		1667		
1668 'Canadian' violin	B one piece top 1660	1476				1660	1668		V/52
1669 'Francalucci', 'Clisbee' violin *	bass 1646			1558		1646	1669		I/54
	treble 1645			1555		1645	1669		
1670–1680 'Klamroth' violin *	bass 1670				1581	1670	1675		V/60
	treble 1664				1580	1664	1675		
1677 'Sunrise' violin	B one piece top 1652		1502			1652	1677		I/96
1679 'Hellier' violin *	bass 1669			1527		1669	1679		I/104
	treble 1667			1525		1667	1679		
1679 'Parera' violin	T one piece top 1669				1571	1669	1679		I/112
1679 'Sabionari' guitar *	bass 1618	1488			1618		1679		V/68
	treble 1620	1491			1620		1679		
1681 'Count de Lachenais', 'Reynier' violin *	bass 1675				1605	1675	1681		I/120
	treble 1674				1600	1674	1681		
1682 'Chigiano' cello *	bass 1680			1564		1680	1682		V/98
	treble 1682			1566		1682	1682		
1683 'Bucher' violin	B one piece top 1670			1568		1670	1683		V/110
1683 'Cipriani Potter' violin *	bass 1671				1602	1671	1683		V/118
	treble 1677				1603	1677	1683		
c.1686 'Golden Bell' violin	B one piece top 1648	1471				1648	1686		I/152
c.1686 'Rosgonyl' violin *	bass 1665			1578		1665	1686		I/160
	treble 1668			1578		1668	1686		
1687 'Bello', 'Marie Law' violin	bass 1681				1577	1681	1687		V/154
	treble 1674			1540		1674	1687		



# Antonius Stradiuarius

*Dendrochronology*

---

*Vol I-VIII*

---

*Music*

---

*CT-Scans*

---

*360° Turns*

---

*Violin 1667 Jenkins'*



*Violin 1667 Jenkins'*



*Violin 1667 Jenkins'*

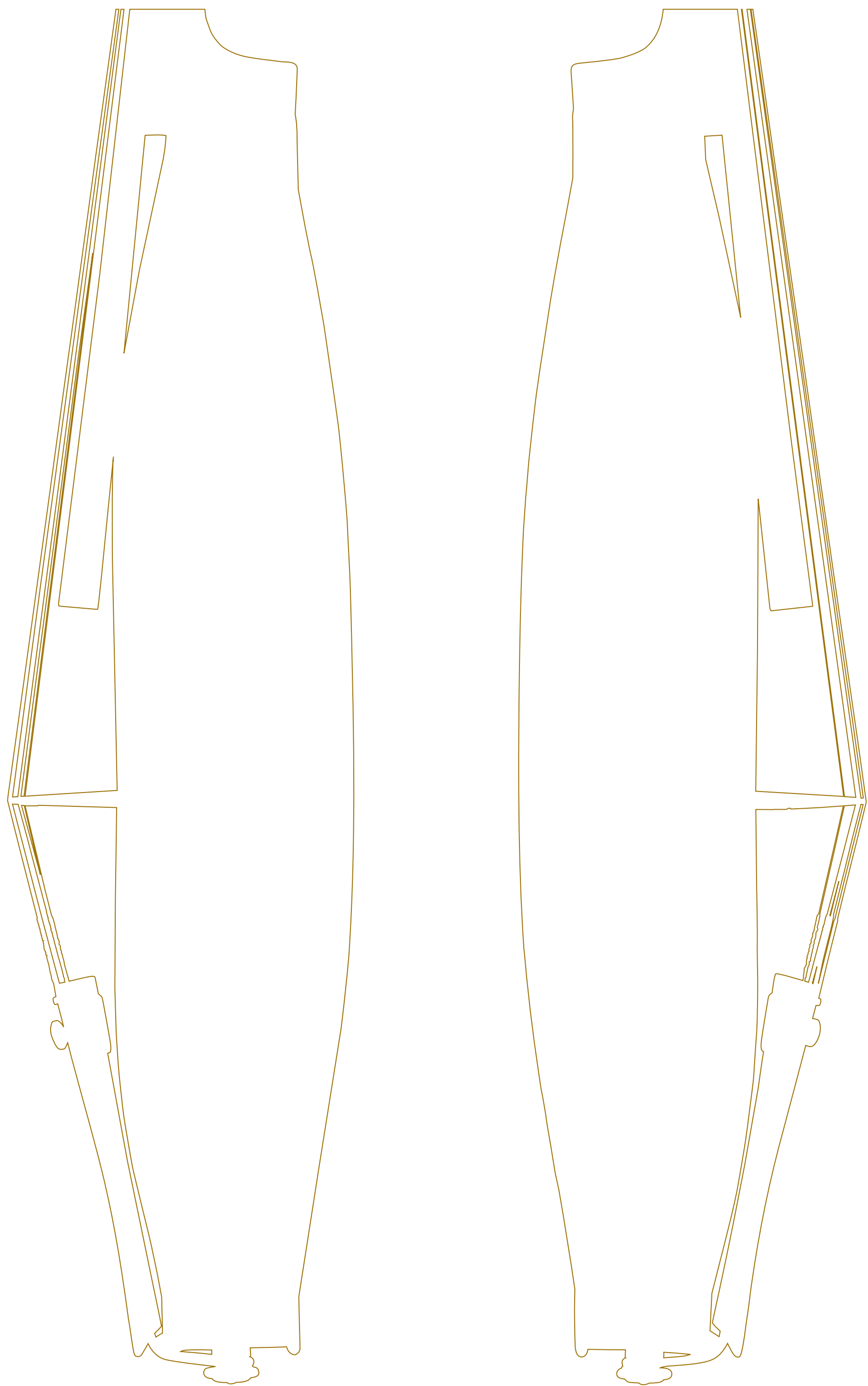

*Violin 1667 Jenkins'*

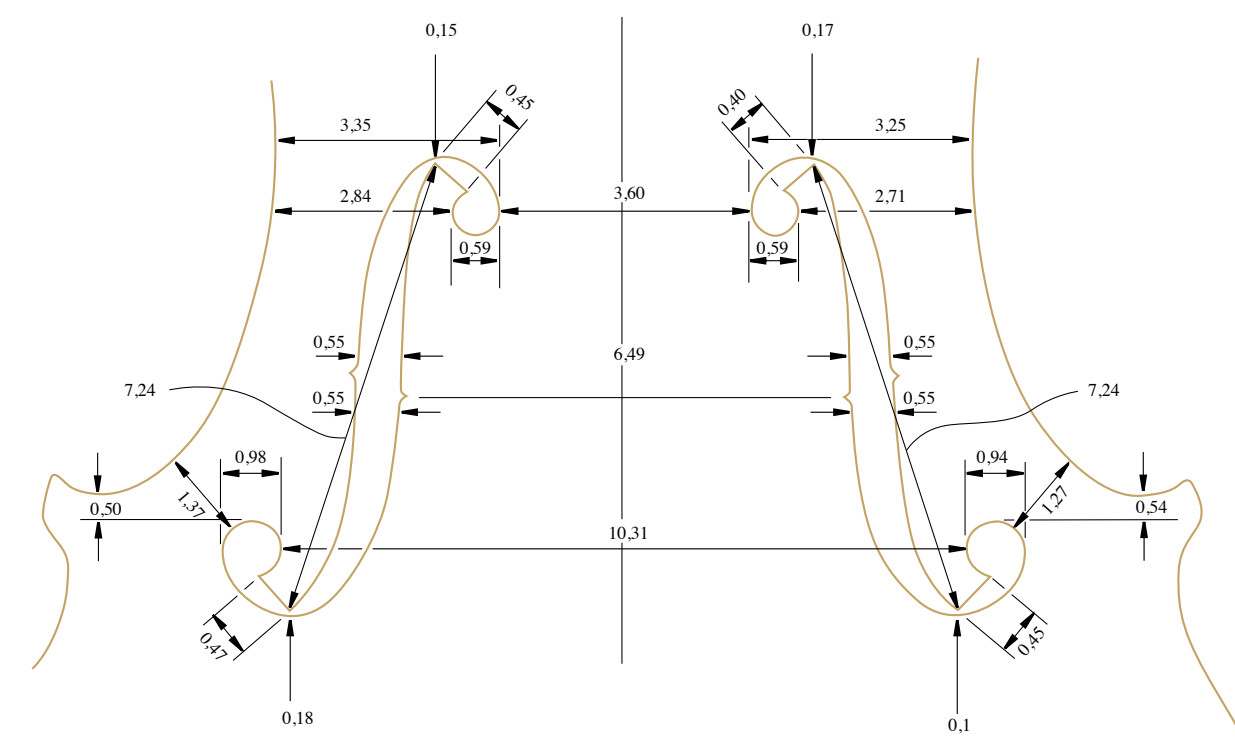
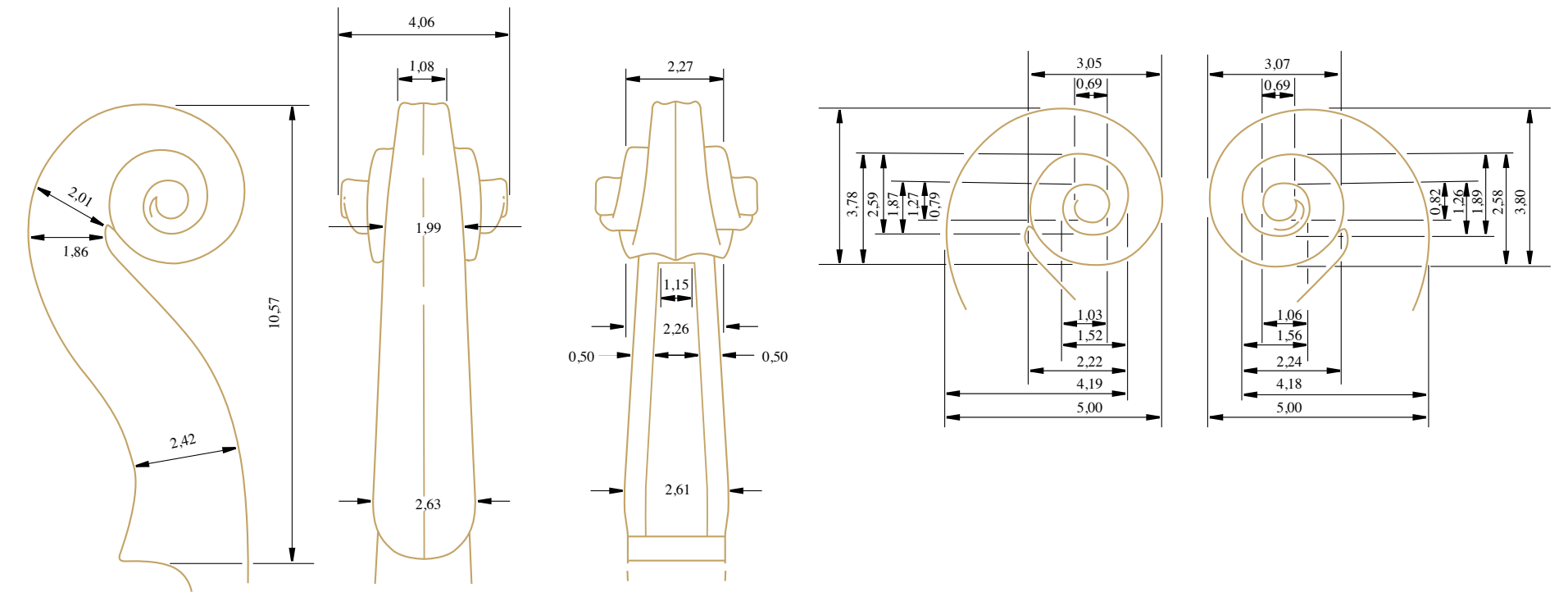
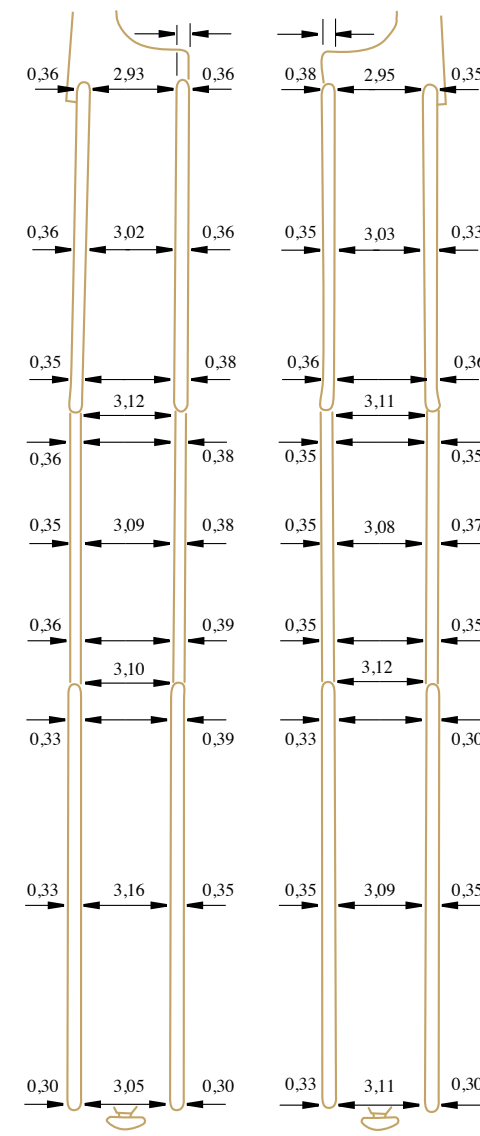
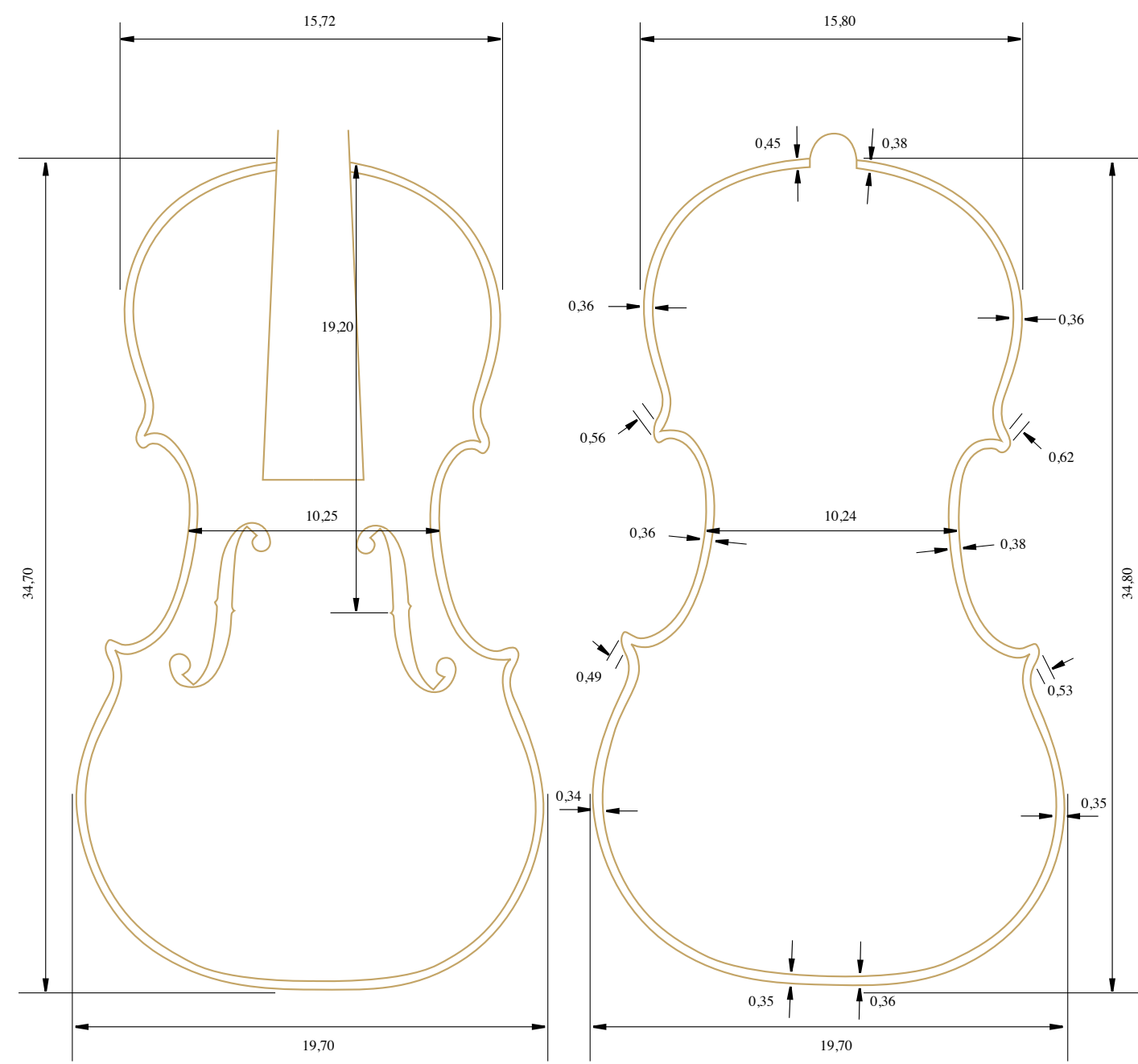





# Antonius Stradiuarius

*Dendrochronology*

---

*Vol I-VIII*

---

*Music*

---

*CT-Scans*

---

*360° Turns*

---

Antonio Stradivari, Cremona 1699, "Ex-Auer"



Antonio Stradivari, Cremona 1699, „Ex-Auer“

Back, thickness-map

VIOLIN FORENSIC

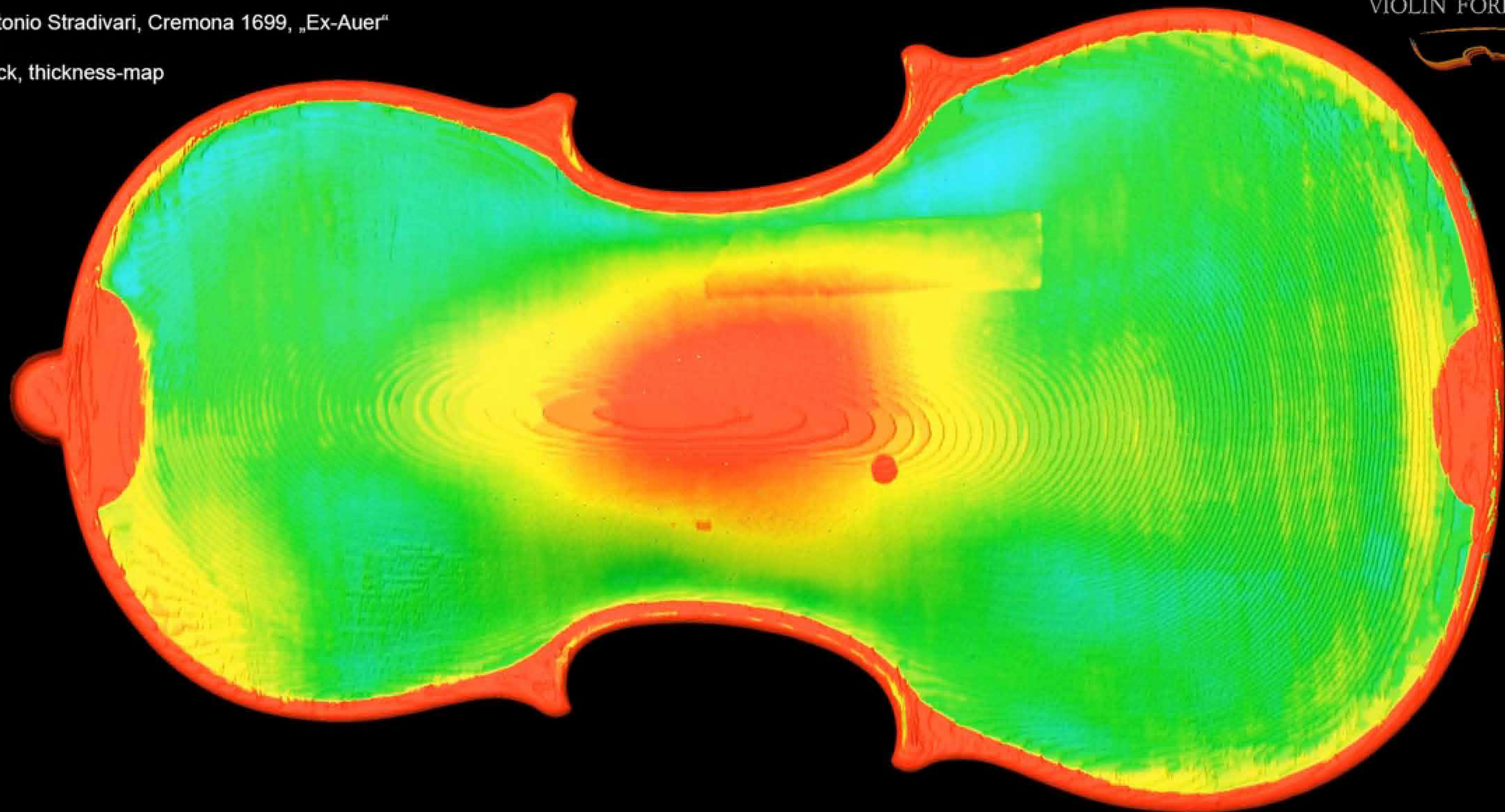



# Antonius Stradiuarius

*Dendrochronology*

---

*Vol I-VIII*

---

*Music*

---

*CT-Scans*

---

*360° Turns*

---

*Auditions*

Instrument	Composer	Track	Length
1683-1685 'Arma Senkrah' violin	Ludwig van Beethoven (1770-1827)	Trio for Violin, Violoncello & Piano Op 70, 2 E Flat Major, Finale Allegro Bogdan Bozovic vl, Vienna Piano Trio (Dabringhaus und Grimm-Detmold -2014- MDG 942-1842-6)	8:30
c.1686 'The Rosgonyl' violin	Johann Sebastian Bach (1685-1750)	Partita No 1 in b minor, BWV 1002 VI. Double of Sarabande Partita No 1 in b minor, BWV 1002 VII. Tempo di Borea Eugene Drucker vl (Holy Trinity Church, New York City, 1988)	2:59 3:26
1687 'Traunstein, Witter' violin	Johann Sebastian Bach (1685-1750)	Sonata No 2 in a minor BWV 1003, Grave Sean Carpenter vl (private)	3:53
1688 'Marchese Guido Borgomanero' violin	Vittorio Monti (1868-1922) Pyotr Ilyich Tchaikovsky (1840-1893)	Csárdás for Violin and Piano Melodia Op 42 No 3 Alessandro Borgomanero vl, Wolney Unes piano (private - Recital Violino & Piano)	4:50 3:12
1689 'Ragin' violin	Jenö Hubay (1858-1937)	Hubay Violin Concerto No 3 in g minor Adagio Ragin Wenk-Wolff vl, Slovak Radio Symphony Orchestra (Centaur, CRC 2790 2006, www.centaurrecords.com)	10:22
1691 'Auer' violin	Béla Bartok (1881-1945)	Romanian Folk Dances 1 Romanian Folk Dances 2 Kerson Leong vl (17) (Courtesy of Groupe Analekta inc. All Rights Reserved, Used by Permission)	3:16 4:01
1691 'Ginn' violin	Johann Sebastian Bach (1685-1750)	Sonata No 3 in C Major BWV 1005, Largo Sonata No 3 in C Major BWV 1005, Allegro Sean Carpenter vl (private)	3:04 2:40
1691 'Hilton' violin	Claude Debussy (1862-1918)	Violin Sonata in g minor - 1 Allegro Vivo Violin Sonata in g minor - 2 Intermède Violin Sonata in g minor - 3 Finale Très Animé Frank Peter Zimmermann vl, The Philharmonia (EMI classics – Holland 1992)	5:22 4:11 4:36



# Antonius Stradiuarius

*Dendrochronology*

---

*Vol I-VIII*

---

*Music*

---

*CT-Scans*

---

*360° Turns*

---





# Antonius Stradiuarius

*Book Samples*

*DVD Samples*

